

GAGE BILT

GB714BBK & GB714BBK-1 Blind Bolt Kits



GB714BBK-1 SHOWN

GAGE BILT offers a complete tool kit for installing Huck® and Cherry® blind bolts per MS21140 & MS21141 (U or S) and MS90353 & MS90354 (U or S).

The basic kit, GB714BBK, contains a straight nose to install -5 (5/32"), -6 (3/16") and -8 (1/4") diameter blind rivets, bleeder bottle, pintail catcher bag and a grip selector gage.

The dash one kit also contains right angle and offset noses, must-have items for re-work operations.

All these items are stored in an easy access carrying case with a manual and data sheets.

GB714BBK & GB714BBK-1 Blind Bolt Kits

QTY	COMPONENT	DESCRIPTION	NOTE	GB714BBK	GB714BBK-1
1	GB714	INSTALL TOOL		X	X
1	SB05-752C-20	NOSE ASSY		X	X
1	SB06-752B-20	NOSE ASSY		X	X
1	SB08-713-20	NOSE ASSY		X	X
1	SB05-751C-54RA	NOSE ASSY RT ANGLE	USE 714152		X
1	SB06-751B-54RA	NOSE ASSY RT ANGLE MAINTENANCE	USE 714152		X
1	SB08-713A-58RA	NOSE ASSY RT ANGLE			X
1	SB05-752A-43OS	NOSE ASSY OFFSET			X
1	SB06-204D-27OS	NOSE ASSY OFFSET	USE 751204		X
1	SB08-204D-27OS	NOSE ASSY OFFSET	USE 751204		X
1	GB105093	GRIP GAGE		X	X
1	751204	ADAPTER ASSY			X
1	714152	STROKE LIMITER			X
1	704153	AIR BLEEDER ASSY		X	X
1	756610	CATCHER BAG-STEM		X	X
1	713303	CARRYING CASE ASSY (GB713BBK)		X	
1	713304	CARRYING CASE ASSY (GB713BBK-1)			X

Please view the back of this flyer for pictures of your MS fasteners and noses to match.

GAGE BILT



MADE in USA









INNOVATIVETOOLING
On the leading edge of Aircraft Tooling

800-832-7009

sales@innovativetooling.com

innovativetooling.com

BLIND BOLT	DIA.	NOSE ASSEMBLIES			RIVET NUMBER
		STRAIGHT	RIGHT ANGLE	OFFSET	
	5/32"	*SB05-752C-20	***SB05-751C-54RA	SB05-752A-43OS	MS90353S & U & MS90354S & U MS21140S & U & MS21141S & U CR7000 SERIES BACB30YY, YU, & YT
	5/32"				
	3/16"	*SB06-752B-20	***SB06-751B-54RA	**SB06-204D-27OS	
	3/16"				
	1/4"	*SB08-713-20	SB08-713A-58RA	**SB08-204D-27OS	
	1/4"				
	1/4"				

*NOSES LISTED PROTRUDE 2 INCHES FROM THE TOOL. LONGER NOSES ARE AVAILABLE.

**REQUIRES 751204 ADAPTER ASSY

***REQUIRES 714152 STROKE LIMITER
FOR 4.5 INCHES ORDER SBXX-752B-45
FOR 8.0 INCHES ORDER SBXX-752B-80

STRAIGHT

RIGHT ANGLE

OFFSET

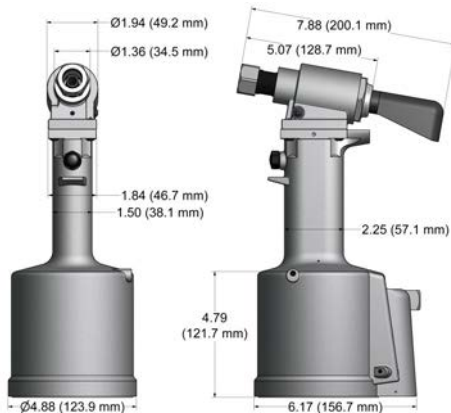
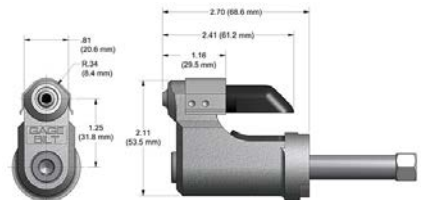
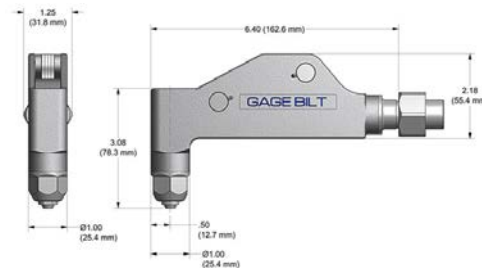
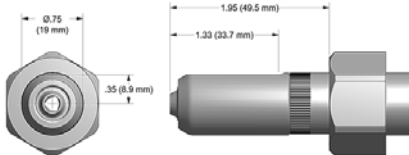
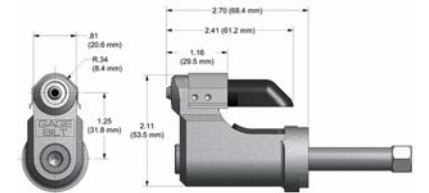
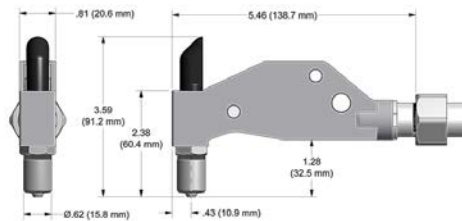
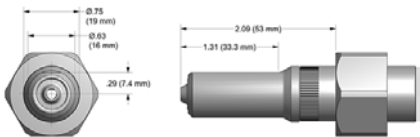
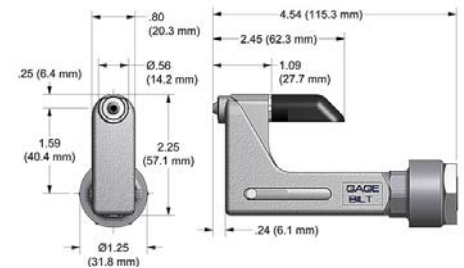
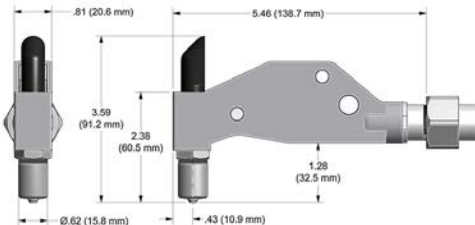
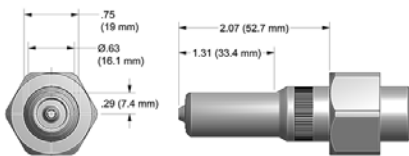

INNOVATIVETOOLING
On the leading edge of Aircraft Tooling

800-832-7009

sales@innovativetooling.com

innovativetooling.com